

STANDARD DIMENSIONS (MODEL 700 DGC) (WITH SS CASE AND FLANGE CASE)

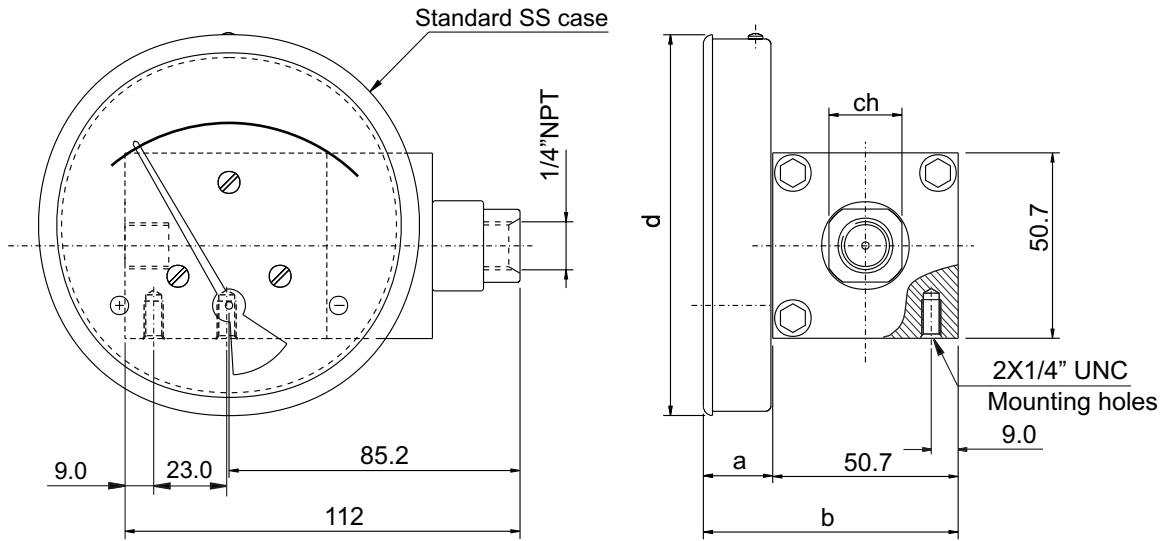

DIAL Ø	a	b	d	ch
63 (2.5")	19	69.7	66	20
80 (3.5")	19	69.7	83	20
100 (4")	19	69.7	104.3	20
115(4.5")	19	69.7	119.7	20
150(6")	19	69.7	154.3	20

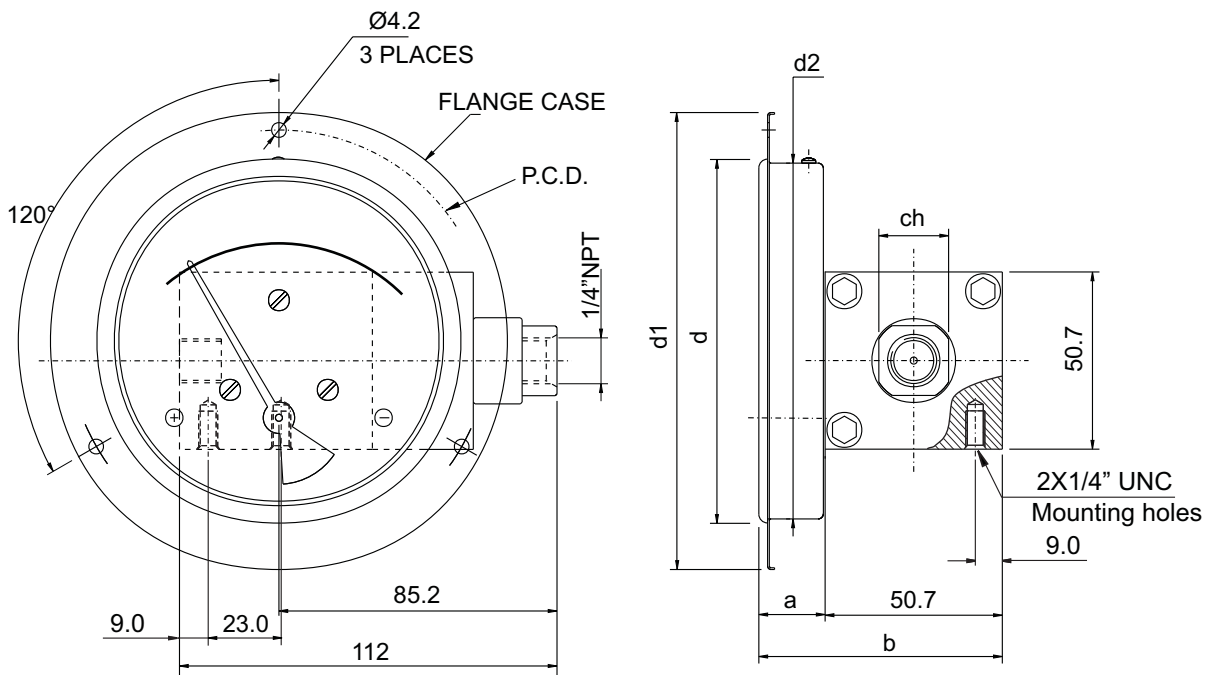

DIAL Ø	a	b	d1	d2	ch	p.c.d.	d *
63(2.5")	19	69.7	93	65	20	83	66
80(3.5")	19	69.7	109	82	20	99	83
100(4")	19	69.7	131	102	20	121	104.3
115(4.5")	19	69.7	146	117	20	136	119.7
150(6")	19	69.7	181	152.5	20	171	154.3

* PANEL CUTOUT = d + 1

STANDARD DIMENSIONS (MODEL 700 DGC) WITH ENGINEERING POLYMER CASE

(SD) 2-1/2" DIAL SIZE

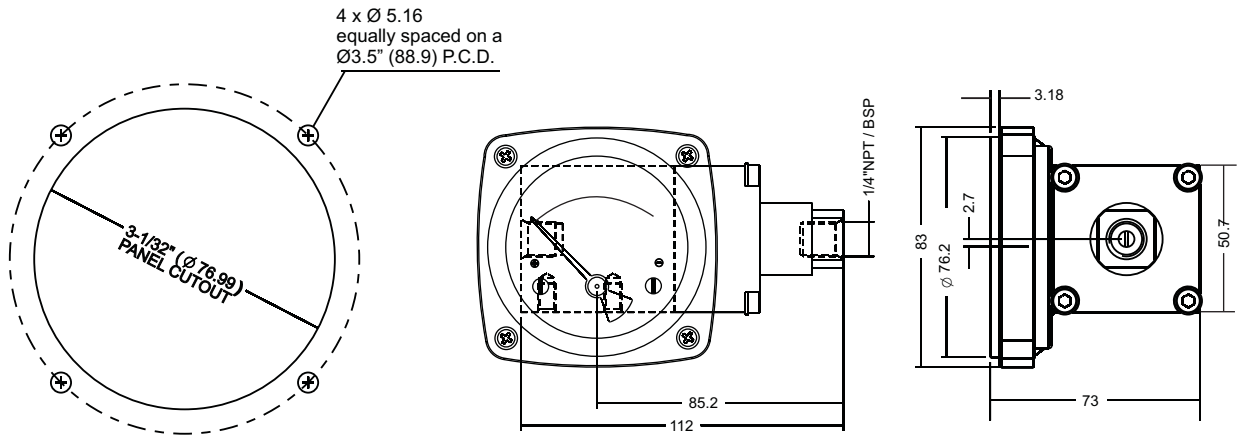

(RD) 4-1/2" DIAL SIZE

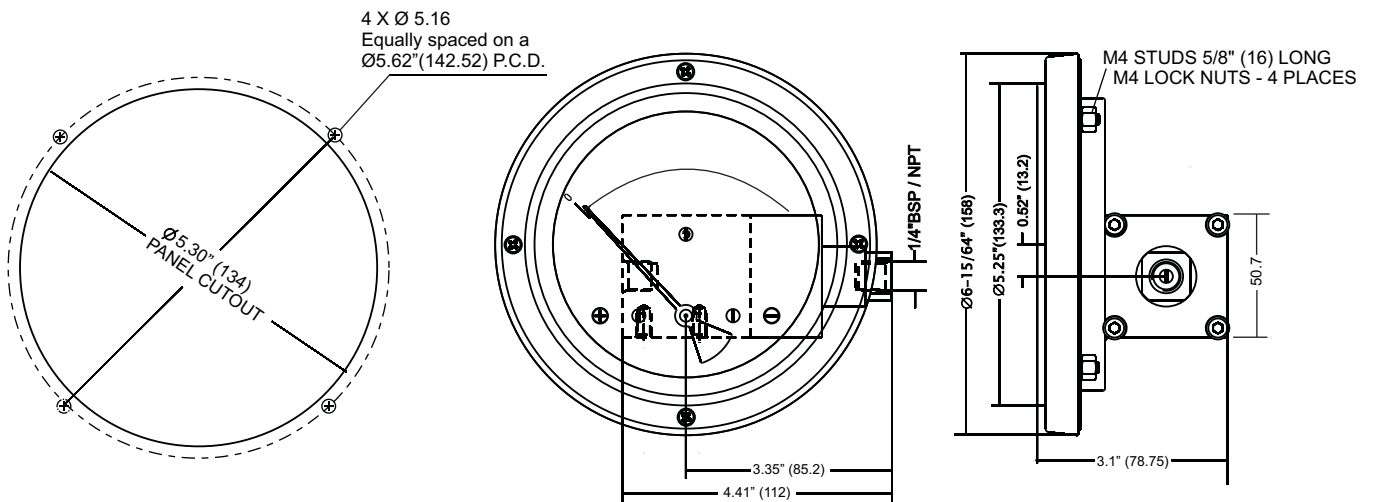

(LD) 6.0" DIAL SIZE

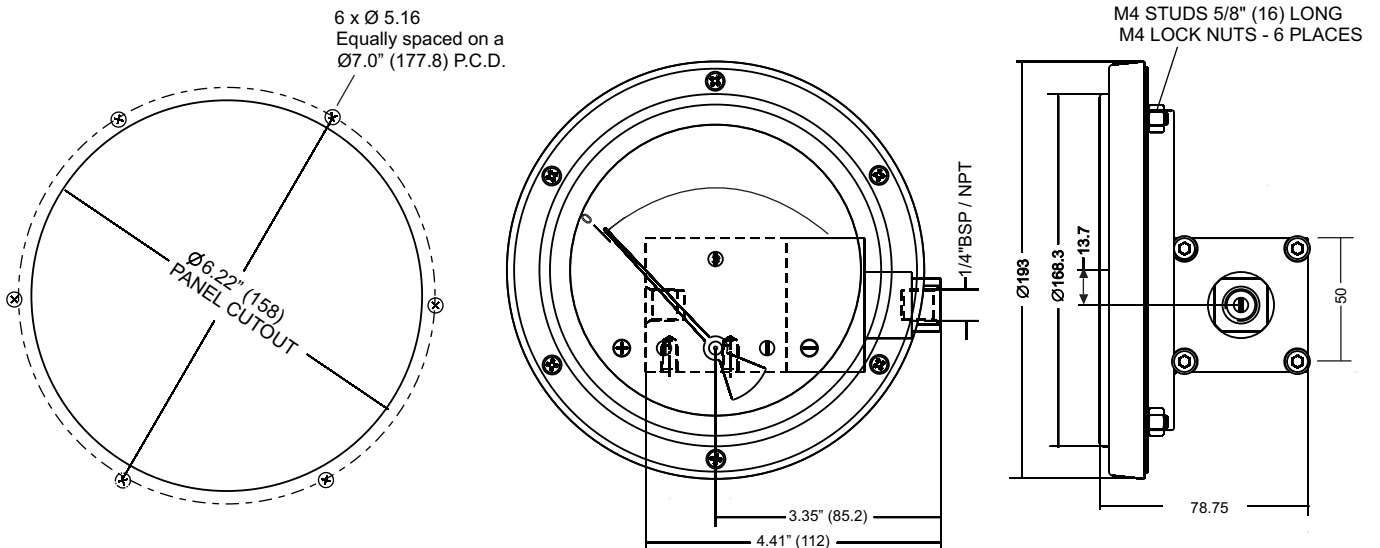

**GAUGE + SWITCH WITH REED CONTACTS WITH DIN PLUG AND TERMINAL STRIP
(MODEL 700 DGC)**

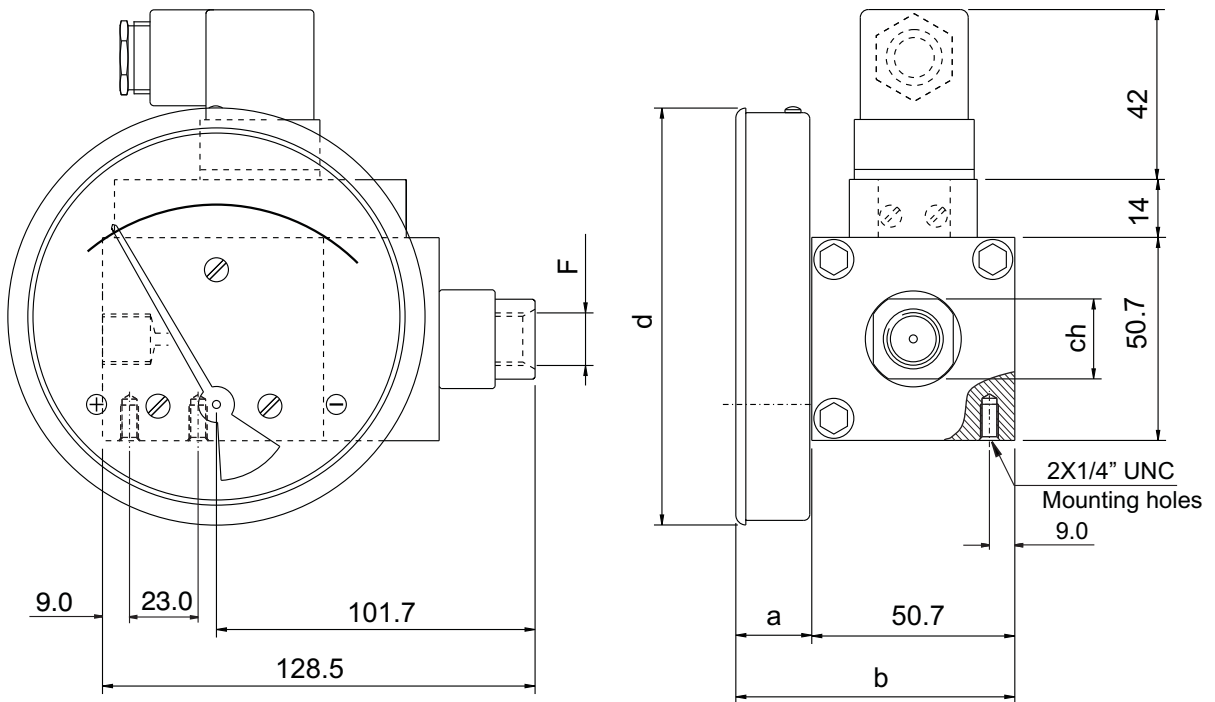

DIAL Ø	F	a	b	d	ch
63	1/4"BSP - 1/4"NPT	19	69.7	66	20
80	1/4"BSP - 1/4"NPT	19	69.7	83	20
100	1/4"BSP - 1/4"NPT	19	69.7	104.3	20
115	1/4"BSP - 1/4"NPT	19	69.7	119.7	20
150	1/4"BSP - 1/4"NPT	19	69.7	154.3	20

