

## INSTALLATION INSTRUCTIONS

# Model DX-20

## DIAPHRAGM INSTRUMENTS

### DIFFERENTIAL PRESSURE INSTRUMENT / SWITCH

For efficient working of your instrument, please read all instructions carefully before attempting to install.

**CAUTION** : Do not exceed maximum operating pressure given on the instrument label.

Check fluid compatibility with wetted parts before use.

**For highly corrosive media, hazardous location or area please contact manufacturer.**

### OPERATING PRINCIPLE

High and Low pressures are separated by a sensor assembly consisting of a magnet, diaphragm and a range spring. The difference in pressure causes the sensor assembly to move in proportion to the change against a range spring.

A rotary magnet, located in a separate body compartment and isolated from the acting pressures, is rotated by magnetic coupling as per the linear movement of the sensor assembly. A pointer attached to the rotary magnet indicates differential pressure on the dial.

**SWITCH** : Reed switches are located adjacent to the pressure chamber and are activated by the magnetic field of the sensor assembly.

**Note** : The instruments are calibrated to give  $\pm 5\%$  full scale accuracy on ascending readings.

### INSTALLATION

For better performance the instrument should be mounted horizontally by keeping the dial vertical. Select instrument location where it is not subjected to heavy vibrations or shocks.

Depressurize the system and connect the high and low pressure lines of your system to the " High " & " Low " ports of the instrument, respectively.

It is recommended to use "O" rings with male connectors to avoid excessive tightening and to prevent leakage (For parallel threads). The instrument is now ready for operation.

Apply "High" and "Low" pressures simultaneously, to avoid damage to the internal parts.

Model DX-20 consists of a diaphragm to sense the pressure difference. It can withstand maximum operating pressure up to 100 bar & temperature up to 80°C max. for all ranges.

If pressure exceeds the rated maximum pressure, "O" rings and diaphragm inside the pressure chamber will be damaged.

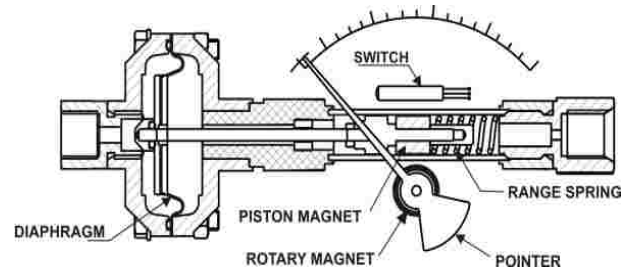

If maximum operating pressure is within the maximum specified pressure for the instruments, but the differential pressure exceeds instrument range, there will be no damage to the instrument. Pointer will only go to the extreme right end of the scale.

### PRECAUTIONS

Do not connect "High" and "Low" ports to wrong pipe ends. Avoid subjecting the instrument to excessive vibration.

The instrument is never to be used in an area where a magnetic field is present. It may show wrong readings.

As the instrument works on magnetic coupling, use only non magnetic fittings, parts etc. in areas closer than 50 mm on all sides, Otherwise calibration will get effected. Panel mounted instruments should be installed in non-ferrous panel material.

Do not try to open any part of the instrument for any reason, because if not reassembled properly calibration will be affected.

### Measures to be taken by customer in the case of returns and repairs

#### Hazardous working materials

We would ask for instruments returned or sent in for repair, which have hazardous materials in the media areas and/or have surface contact with hazardous materials, to be cleaned beforehand and an as accurate as possible description of the hazardous medium. It is absolutely essential to provide exact details of the media or its composition and processing instructions including safety measures to be taken to safeguard the ambient for our acceptance and maintenance personnel.

**Important** : Working materials not to be disposed off by are returned to the customer, Marking and packaging in accordance with hazardous materials

### SWITCH SETTING (DX-20)

Please follow these instructions when your differential Pressure instruments are supplied with switch. The switches are normally factory set to save time at customer's end. However they are field adjustable.

**CAUTION :** Supply should not exceed switch rating.

## SWITCH ADJUSTMENT

Switch adjustment screw is located on plastic cover.

Rotate the screw anti-clockwise to increase the set point and clockwise to decrease the set point.

One or two trials may be necessary to attain the exact set point.

Above procedure to be followed by putting the instrument on test bed or while in actual service.

**NOTE :** Instrument and switch has IP65 protection.  
PG 9 gland is provided for cable.

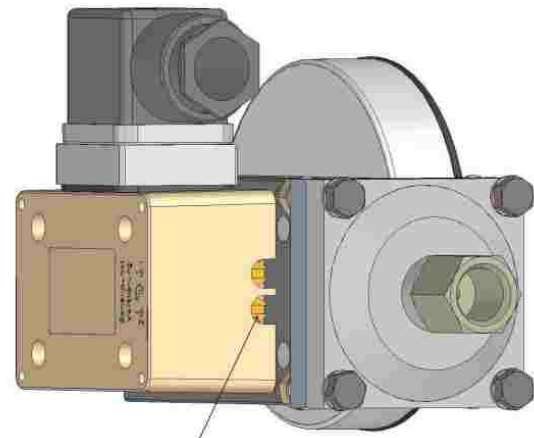

Increase set point anticlockwise

View from high pressure side

## SPST SWITCH

### Specifications

Switches are provided as per customer requirement.  
Please refer gauge label for switch specifications.

#### One SPST switch

##### Reed switches & terminal strip connection

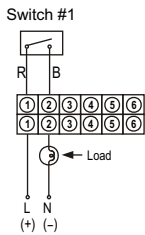

##### Reed switches & Din plug connection

###### View of socket for supply connections

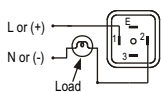

###### View of plug after removing the socket

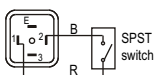

#### Two SPST switches

##### Reed switches & terminal strip connection

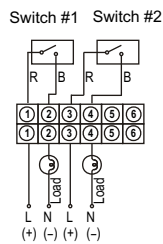

##### Reed switches & Din plug connection

###### View of socket for supply connections

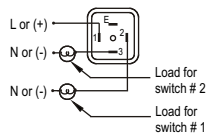

###### View of plug after removing the socket

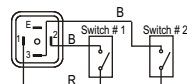

## SPDT SWITCH

### Specifications

Switches are provided :  
Please refer gauge label for switch specifications.

#### One SPDT switch

##### Reed switches & terminal strip connection

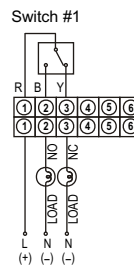

##### Reed switches & Din plug connection

###### View of socket for supply connections

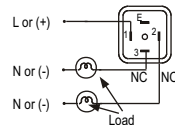

###### View of plug after removing the socket

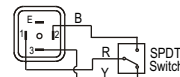

#### Two SPDT switches

##### Reed switches & terminal strip connection

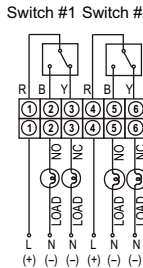

R=Red, B=Black, Y=Yellow, L=Live or +ve supply, N=Nutral or -ve supply  
\* Body to be suitably earthed while using gauge + switch and only switch.